

# Niigata University Medical and Dental Hospital

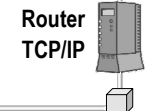

## General Analysis

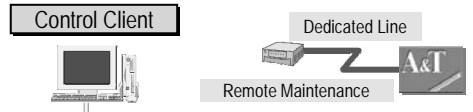
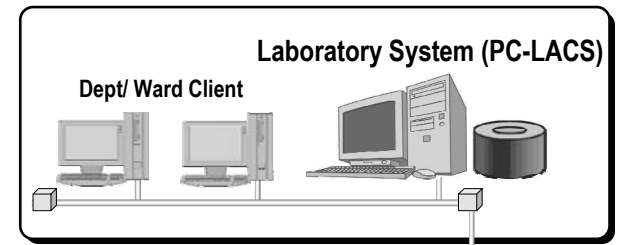
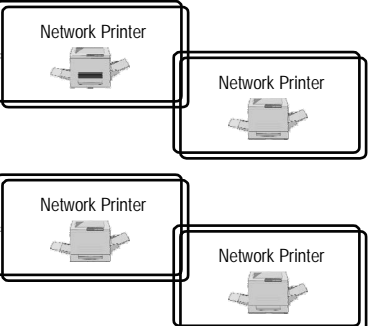
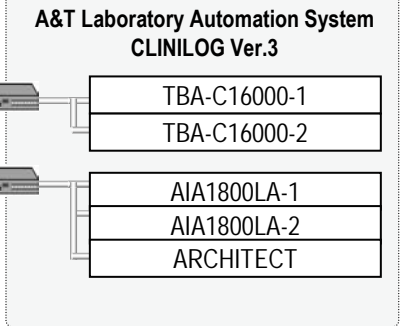
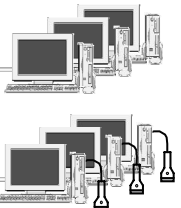

## General Analysis

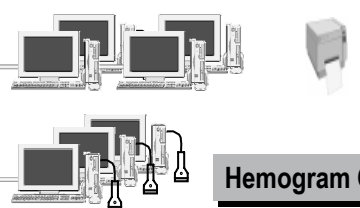

### Hemogram Counter

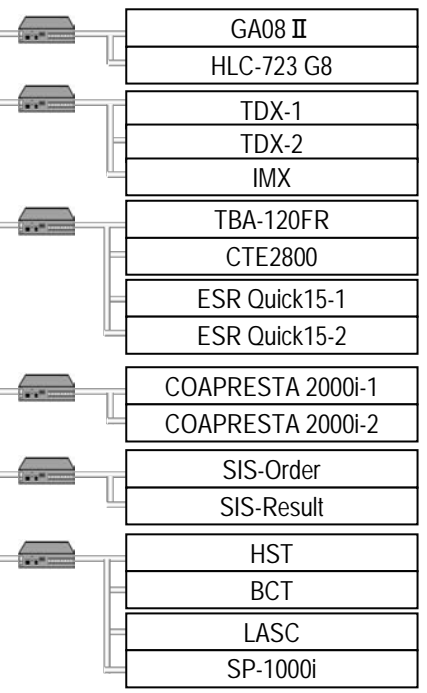

## Urinalysis

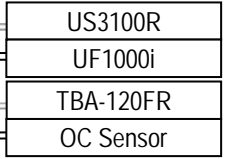

## Urine Sediment Counter

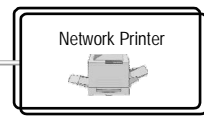
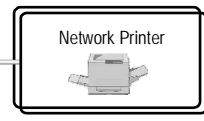
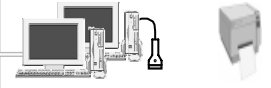
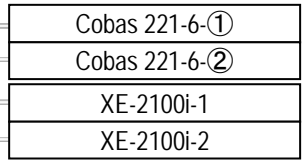
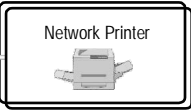

## Supervisor

